

Owners Manual

Öhlins shock absorbers, VOR MX, Enduro, Super Motard



Including:

Safety

Tuning the
suspension

Design
features

Function

Basic
adjustments

Fine tuning

Inspection,
maintenance

Safety signals

Important information concerning safety is distinguished in this manual by the following notations:



*The Safety alert symbol means:
Caution! Your safety is involved.*

WARNING!

*Failure to follow warning instructions could result in **severe or fatal injury** to anyone working with, inspecting or using the suspension, or to bystanders.*

CAUTION!

Caution indicates that special precautions must be taken to avoid damage to the suspension.

NOTE!

This indicates information that is of importance with regard to procedures.

Introduction

All of Öhlins advanced suspension products are adapted to the brand and model. This means that length, travel spring action and damping characteristics, are tested individually just for the motorcycle that you have decided to fit with Öhlins suspension.

Before installation

Öhlins Racing AB can not be held responsible for any damage whatsoever to shock absorber or vehicle, or injury to persons, if the instructions for fitting and maintenance are not followed exactly.

Similarly, the warranty will become null and void if the instructions are not adhered to.

Contents

Safety signals	2
Introduction	2
Before installation	2
Tuning the suspension	3
Design	3
Function	4
Settings	5
Setting the spring pre-load	5
Setting the shock absorber length	6
Setting the damping	7
Setting your motorcycle	8
Inspection and maintenance	9
General handling setup	10

WARNING!

1. Installing a shock absorber, that is not approved by the vehicle manufacturer, may affect the stability of your vehicle. Öhlins Racing AB cannot be held responsible for any personal injury or damage whatsoever that may occur after fitting the shock absorber. Contact an Öhlins dealer or other qualified person for advice.

2. Please study and make certain that you fully understand all the mounting instructions and the owners manuals before handling this shock absorber kit. If you have any questions regarding proper installation procedures, contact an Öhlins dealer or other qualified person.

3. The vehicle service manual must be referred to when installing the Öhlins shock absorber.

NOTE

Öhlins products are subject to continual improvement and development. Consequently, although these instructions include the most up-to-date information available at the time of printing, there may be minor differences between your suspension and this manual. Please consult your Öhlins dealer if you have any questions with regard to the contents of the manual.

© Öhlins Racing AB.

All rights reserved.

Any reprinting or unauthorized use without the written permission of Öhlins Racing AB is prohibited.

Printed in Sweden.

1. Design principles

1. External reservoir with hose connection
2. External piggyback reservoir
3. Internal gas reservoir
4. Twin piston shock absorber

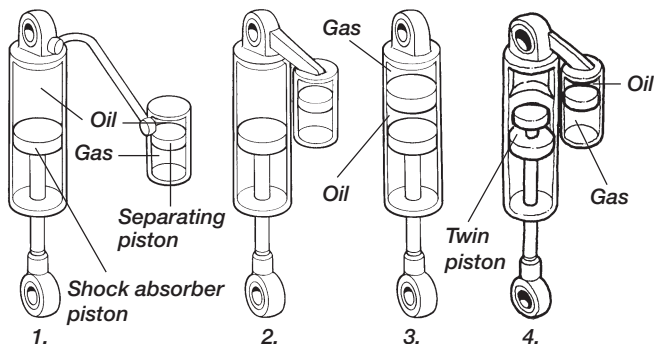

2. Spring pre-loading

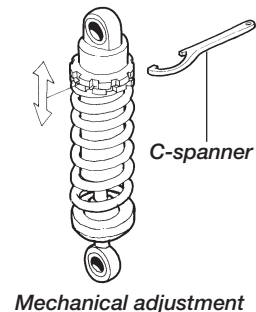

3. Adjustment of shock absorber length

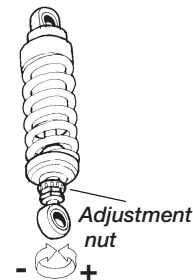

Tuning the suspension

Motorcycle road holding qualities

All motorcycles are designed with a suspension geometry that includes height and fork angle. The changing of components can affect this and it is therefore essential that both the rear and the front ends match each other.

Changing to Öhlins suspension gives optimum performance only when both the front fork and the rear suspension interact properly. It is of the greatest importance that the front and rear loaded heights are within the specified values.

In the Mounting Instruction, see section: *Setting the spring pre-load*.

Design

Most of the Öhlins shock absorbers are of the De Carbon type (Fig.1). The fluid is put under gas pressure and the gas and the fluid are kept apart by a separating piston. The separating piston is often fitted in a separate fluid chamber, connected by hose (Fig.1:1), or fixed directly on top of the shock absorber (piggyback) (Fig.1:2).

There are also cases where everything is fitted inside the main shock absorber (internal gas reservoir) (Fig.1:3).

The most advanced shock absorber has twin pistons. This ensures position sensitive damping in relation to the degree of compression. One of the pistons is active throughout the entire length of stroke, while the second piston begins to work in the event of powerful compression of the shock absorber (Fig.1:4)

Pressurisation of the fluid is made with nitrogen. The pressurisation prevents cavitation of the fluid and the shock absorbing action is therefore more even.

The external fluid chambers also contribute to better cooling of the fluid, giving longer service life for both the fluid and components.

Öhlins shock absorbers have integrated temperature compensation. As the temperature increases and the fluid flows more easily the flow is controlled accordingly. The shock absorbing effect is therefore independent of the temperature.

The more advanced models permit individual adjustment of compression damping and rebound damping.

Öhlins shock absorbers provide the possibility for adjustment, making them adaptable to most motorcycles, riders and ranges of use. All of the shock absorbers have adjustable pre-loading of the spring action (Fig.2).

A few models have an adjustable end eye, making it possible to alter the length of the shock absorber by 12 mm (Fig.3).

4. Flow through needle valve

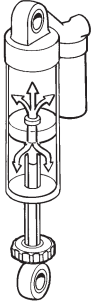

5. Piston with apertures

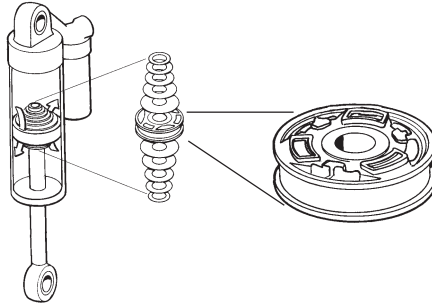

6. Shims stack

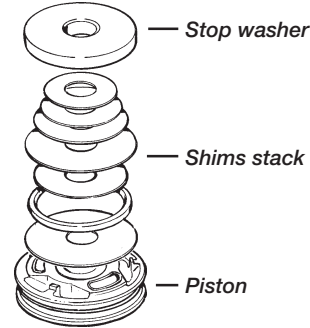

7. Flow through piston

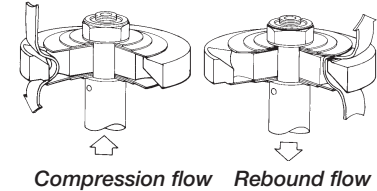

Function

The function, in principle, is that fluid is forced through needle valves at a low rate of flow (Fig.4) and through a number of apertures in the piston (Fig.5) at a high rate of flow. The flow through these apertures is regulated by shims (thin steel washers) that at high pressure are deflected to open for the fluid. On most models the needle valves can be set individually.

By altering the size of the shims stack (Fig.6) (i.e., number, thickness, diameter) the characteristics of the damping action can be changed (this should only be done by Öhlins authorized service workshops).

Compression damping

When movement of the motorcycle causes compression in the shock absorber, the fluid flows through the needle valve (combined compression and return valve) in the piston rod. If the velocity of the piston is high, i.e., in the case of rapid compression, this will not be sufficient and consequently the shims underneath the piston will open to allow a greater rate of flow (Fig.7).

The fluid that is displaced by the volume of the piston rod is forced into the external fluid chamber via a separate compression valve. The separating piston is displaced, thus increasing the gas pressure.

Rebound damping

When the spring forces the shock absorber to extend again, the fluid flows back through the needle valve into the piston rod. The fluid flowing into the chamber is forced by the pressure of the gas back into the shock absorber via a separate non-return valve.

If velocity of the piston is high, the shims on top of the piston will also open to allow the fluid to flow through (Fig.7).

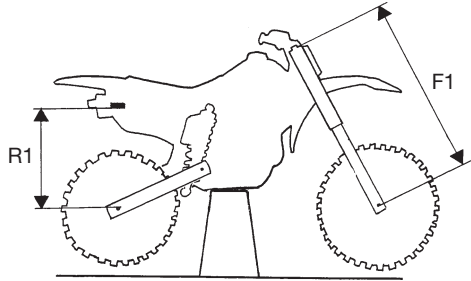

Bike on a stand.

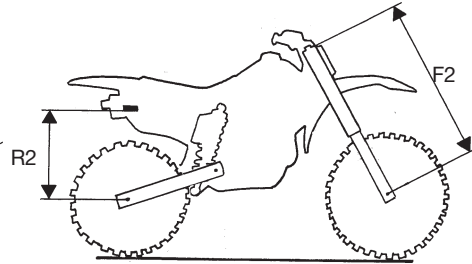

Bike on the ground.

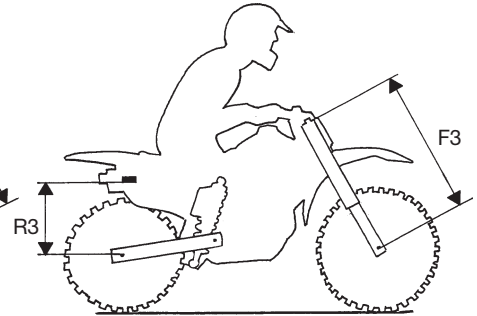

Bike with rider on.

Settings

Basic settings

Always ensure that the basic setting made by Öhlins is correct. It is adapted to the make and model (in its original state) and for a rider of average weight.

WARNING

Incorrect spring action may produce a fork angle that is too steep or too flat. This in turn will give a tendency for oversteering or understeering, which could seriously affect the handling characteristics of the motorcycle.

The original settings of the shock absorber, when delivered from Öhlins, should always be a base when the settings are changed by use of the adjustment devices.

Setting the spring pre-load

Step 1. Measuring

Pre-load on the spring/springs is very important, because it affects the height of the motorcycle and the fork angle. Consequently, handling characteristics can be changed, even negatively. Proceed as follows (it will be much easier if done by two persons):

- Place the motorcycle on a stand, so the front fork and the rear end are in fully extended position.
- Measure the distance, e.g., from the lower edge of the rear mudguard or from a point marked by a piece of tape, immediately above the rear wheel axle, to the wheel axle (R1).
- Make a similar measurement on the front axle, e.g., from the bottom of the upper fork crown to the front wheel axle (F1).
- Allow the motorcycle (without rider) to apply load on the springs and repeat the measuring procedure (R2, F2).

- Then take the same measurements with the rider and equipment on the motorcycle (R3, F3). It is important that the rider has a correct riding posture, so that the weight is balanced on the front and rear wheel in the same way as when riding.

Recommendations

The difference should not deviate from the following sizes, if no other recommended settings are given in the Mounting instructions:

Free sag: (R1-R2), (F1-F2)

Rear:	MX/Enduro	30±5 mm
	Supermotard	30±5 mm
Front:	MX/Enduro	30±5 mm
	Supermotard	30±5 mm

Ride height: (R1-R3), (F1-F3)

Rear:	MX	100±5 mm
	Enduro	30% of the total stroke
	Supermotard	30% of the total stroke
Front:	MX/Enduro	80±5 mm
	Supermotard	80±5 mm

8. Spring pre-loading

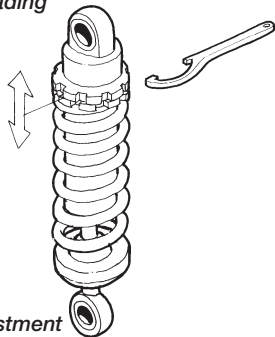

Mechanical pre-loading adjustment

Step 2. Adjusting

Adjust the pre-load with the rings on the shock absorber.

Hold the upper ring and adjust the lower one to the desired position (Fig.8). Then lock with the upper ring.

NOTE!

If ride height is higher than recommended, softer spring/springs must be used.

If ride height is lower than recommended, harder spring/springs must be used.

Contact your Öhlins dealer for advice.

9. Front spring kit

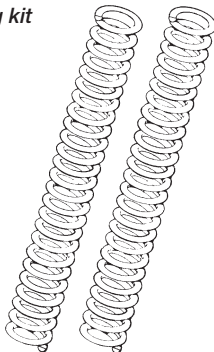

Front fork springs

To optimize the road holding qualities of a motorcycle the front fork must match the rear suspension. Öhlins springs are available for a large number of motorcycles (Fig.9). These, in combination with Öhlins shock absorbers, contribute to superior road holding qualities. The original make of springs should be used if there are none of our springs in the recommendation table. However, they must be in good condition and not fatigued. Remember to change the fluid in the front fork at least once every year. We recommend Öhlins front fork oil.

WARNING!

It is important that the recommendation table is followed for new front springs. If there are no recommended front springs you must ensure that the existing springs are in good condition. Neglecting to check the front springs could seriously affect the handling qualities of the motorcycle.

10. Adjustable end eye

WARNING!

If the shock absorber has an adjustable end eye/bracket, this must not be threaded out so that more than one groove is fully visible beneath the lock nut. Make sure that the lock nut is tightened after adjustment.

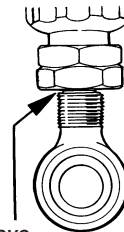

Groove

Setting the shock absorber length

Sensitivity of the steering can be adjusted by altering the length of the shock absorber, without affecting other characteristics. The length is adjusted with the two nuts and the threaded clevis at the end of the piston rod.

The shock absorber can be adjusted up to 12 mm. The length may never be altered more than to where the groove that is cut in the thread becomes fully visible (Fig.10).

11. Adjustment of rebound damping

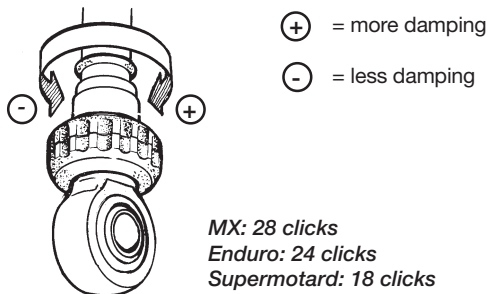

12. High and low speed compression damping adjusters

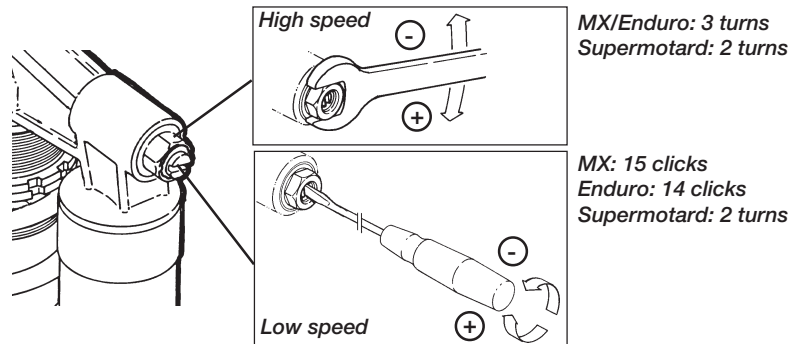

Setting the damping

The adjusting possibilities of Öhlins shock absorbers facilitate fine setting. You can optimize adjustments to suit your own weight and equipment, your individual way of riding and the condition of the road. To be able to improve the road holding qualities it is of the utmost importance that you fully understand the function of the shock absorbers. From there you can learn by trial and error how they affect the motorcycle.

Depending on the model there are adjustments for rebound damping, compression damping and adjustment of the length of the shock absorber. Damping is set with knobs and screws with a normal right-hand thread. By turning you can increase the damping action or reduce it. The adjuster have definite positions with a noticeable “click”, so it is easy to count to the right setting.

Rebound damping action affects the characteristics of the motorcycle most. The setting knob is located at the bottom on the piston rod (Fig.11). It can be adjusted in about 40 steps.

The compression damping adjuster is located at the end of the reservoir (Fig.12).

Compression damping is set with separate adjusters for high speed compression and low speed compression (Fig.12). The low speed compression is adjusted in 25 steps.

The high speed adjuster has a wide range within four (4) turns. Adjust a half turn (180°) at a time.

NOTE!

When making new adjustments it is easiest to go back to fully closed, and then count forward to the new setting. The adjusting device should not be turned too hard.

NOTE!

If no “click” is felt on the rebound adjusting knob the shock absorber must be inspected by an authorized service workshop. It could be due to low gas pressure or lack of oil.

13. Rebound damping

- Unstable
- Loose
- Bouncy

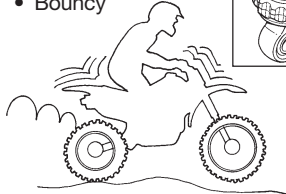
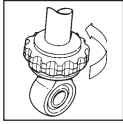

Increase

- Hard
- Bumpy

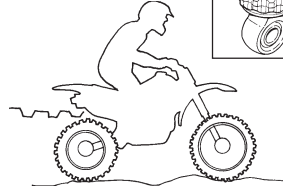
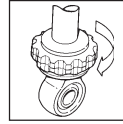

Reduce

- Soft
- Low
- Bottom

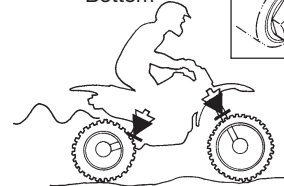
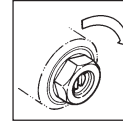

Increase

- Harsh
- Hard

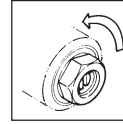

Reduce

14. Compression damping

Setting your motorcycle

NOTE!

Always begin with the basic settings recommended by Öhlins. Always make notes, adjust in small steps and make only one adjustment at a time. Adjustments should be made with two steps (clicks)/ 1/2 turn at a time. Adjustments should not be more than six steps/2 turns from the basic setting.

How to prepare the settings

By utilizing the adjustment possibilities you can test by trial and error, and learn how they affect your motorcycle.

Always begin by test riding the motorcycle with all adjustments at their basic setting. Choose a short run of varying character, i.e., long and sharp bends, hard and soft bumps. Keep to the same run and adjust only one setting at a time.

Start with the rebound damping (Fig. 13)

If the motorcycle feels unstable, loose and rather bouncy then the rebound damping should be increased. Begin by turning the adjusting knob 2 steps (clicks). Test run again and adjust one step back if it felt too hard and bumpy.

If the motorcycle is hard and bumpy, especially over a series of bumps, then the rebound damping should be reduced. Turn 2 steps, test run and make any necessary correction. For original rebound setting see Mounting Instructions.

Compression damping (Fig. 14)

If the motorcycle feels soft, has low riding position and a tendency to bottom easily in long dips then the compression damping should be increased.

If the motorcycle feels harsh and has hard resilience, e.g., during changes in the road paving, then the compression damping must be reduced.

Normally changes are made by high speed compression adjuster only.

Turn 1/2 turn at a time. Test run and make necessary corrections.

When you have sufficient feel of the motorcycle you can make further fine adjustments. It is feeling and experience that counts.

NOTE!

Ensure that the springs are properly pre-loaded before attempting to make any adjustments. A simple rule is that increased pre-load of the spring should be followed by an increase of rebound damping by two steps.

When you feel that you have achieved an improvement, go back to where you started and check once more. Be observant of other relevant factors such as tyres, temperature, etc. Test run to make sure whether further fine adjustment should be made.

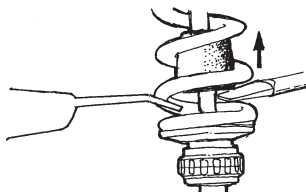

15. Lift the bump rubber and clean the area below.

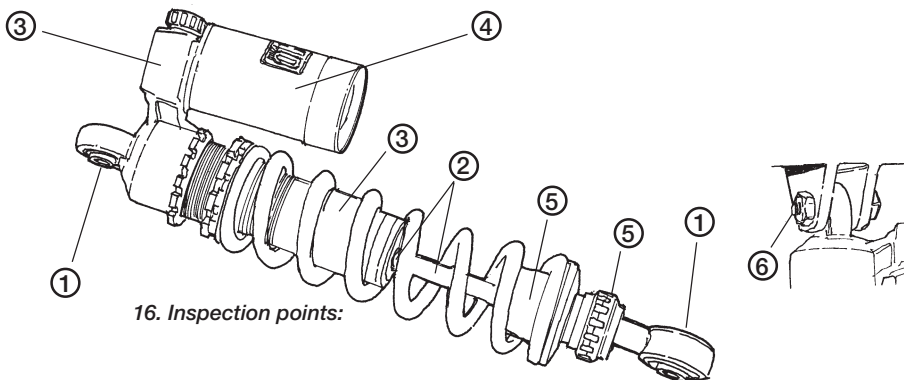

16. Inspection points:

Inspection and maintenance

Clean the shock absorbers externally with a soft detergent . Use compressed air . Be careful that all dirt and debris is removed.

Lift the bump rubber and clean the area below (Fig.15).

Inspection points (Fig.16):

1. Check ball joints for possible excessive play.
 2. Check the piston shaft for leakage and damage.
 3. Check the shock absorber body and for external damages.
 4. Check the external reservoir for damages that can restrict the floating piston from moving freely.
 5. Check for excessive wear of rubber components
 6. Check the fastening to the vehicle
- Check the hose equipped models for leaks in hose and inlet plugs.

Keep the shock absorbers clean and always spray them with oil (QS 14, WR40 or CRC 5-56) after washing the motorcycle.

Preventive maintenance and regular inspection reduces the risk of functional disturbance. If there is any need for additional service, please get in touch with an authorized Öhlins service workshop. There they have the necessary tools and know-how for whatever you need.

NOTE!

Make certain that your shock absorbers are always filled with Öhlins High Performance Shock Absorber Oil.

NOTE!

Regular maintenance and inspection contribute to the prevention of functional disturbances.

Recommended service intervals:

MX & Enduro	Approximately 20 hours of operation
Off Road	2 - 3 times a year

⚠ WARNING!

Never alter the gas pressure. Special purpose charging equipment and access to nitrogen is required. The gas pressure should normally never be altered.

NOTE!

Discarded Öhlins products should be handled over to an authorized work shop or distributor for proper disposal.

General handling set-up

Front end falls into the curves (oversteering) especially in sand.

Steep front fork angle. Front end too low in comparison to rear end.

- Increase the front fork compression damping.
- Change to harder springs.
- Lower fork leg approximately 5 mm in the triple clamp.

Front end "ploughs", understeers.

Shallow front fork angle. Front end too high in comparison to rear end.

- Decrease the front fork compression damping.
- Raise the fork legs approximately 5 mm in the triple clamp.
- Change to softer fork springs.

Front end unstable at high speed, unstable when accelerating out of curves.

Front fork angle too steep. Front end too low in comparison to rear end.

- Lower the fork legs approximately 5 mm in triple clamp.
- Change the front fork springs to harder ones.

Front end unstable during deceleration.

Front fork angle too steep during braking. Front end too low or rear end too high.

- Increase the oil level in the front fork.
- Change to harder fork springs.
- Increase the front fork compression damping.

Front suspension

Front fork travel is not used to its full capacity. Harsh feeling, front wheel grip is not satisfactory in bumpy turns.

Suspension too hard.

- Decrease the front fork compression damping.
- Change to softer springs.

Suspension bottoming, too soft during entire travel.

Spring too weak or compression damping too soft.

- Increase oil level 5 mm.
- Increase compression damping.
- Change to stiffer springs.

Suspension bottoming, but can handle smaller bumps.

Damping force not progressive enough.

- Increase the oil level.

Can handle smaller bumps but is too hard during the last part of the travel.

Damping force is too progressive.

- Decrease the oil level.

Front end feels low, initially feels soft, but is not bottoming.

The initial spring rate is too soft or spring preload is too low.

- Increase the spring pre-load.

Feels harsh over small bumps, but using full wheel travel.

Too much spring pre-load or too much compression damping.

- Increase the oil level or change to softer springs.
- Decrease the compression damping.
- Decrease the spring pre-load.
- Clean the oil seals and scrapers. Use Öhlins red grease 146-01 for regreasing.

Can handle the first in a series of bumps but feels hard after a few more bumps. Frontal grip insufficient in rough and bumpy turns.

Too much rebound damping.

- Decrease the rebound damping.

Front end rebound too fast after a bump. Front wheel grip insufficient in bumpy curves.

Not enough rebound damping, or too much spring pre-load

- Increase the rebound damping.
- Decrease the spring pre-load.

Rear suspension

Rear suspension stroke is not used to its full capacity. Suspension feels harsh. Traction not satisfactory in bumpy curves.

Suspension hard in general or too much compression damping, too much spring pre-load.

- Decrease the compression damping.
- Decrease the rebound damping.
- Change to softer spring.

Suspension is bottoming, feels soft during the entire wheel travel.

Spring too soft, compression damping too low.

- Increase the compression damping.
- Change to harder spring.

Suspension is bottoming, feels harsh and sags down too much with the rider in the saddle.

Spring too soft or compression damping too low.

- Increase the spring pre-load, check ride height: 95 ± 5 mm.
- Change to harder spring if the load is more than 100 mm.
- Increase compression damping.

Rear wheel jumps over small bumps during deceleration or when going downhill. Traction not satisfactory in washboard curves.

Too much spring pre-load, as the spring is probably too soft, will cause the spring to extend too fast.

- Change to a harder spring in order to achieve a balanced position using less spring pre-load.
- Check the static sag and ride height.

Rear end kicks up over bumps with sharp edges, but can handle bumps with round edges.

Compression damping too hard.

- Decrease the compression damping.

Rear end becomes too low in series of bumps. Traction not satisfactory in washboard type curves or when decelerating on washboard ground.

Rebound damping too slow.

- Decrease the rebound damping.

Rear end very unstable. Shock absorber does not respond to adjustments.

Shock absorber damping is gone, caused by low gas pressure, bad oil is used, or components are broken in the shock absorber. Service is needed.

- Gas filling required.
- Change shock oil.
- Repair or change the shock absorber.

NOTE!

Recommended measures are not listed in order of importance.

One of the listed measures can be sufficient to solve a particular handling problem.

More info

www.ohlins.com

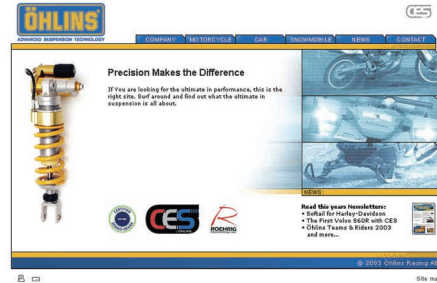

The ultimate suspension site.
Find out everything about your suspension.
Download mounting instructions, manuals and brochures.
And a lot more.



Öhlins Racing AB, Box 722, S-194 27 Upplands Väsby, Sweden
Phone +46 8 590 025 00, Fax +46 8 590 025 80

Your Öhlins dealer: